

# Acrylic Solid Panel Table Top Podium

## ASSEMBLY INSTRUCTIONS

READ ALL INSTRUCTIONS BEFORE YOU BEGIN. DO NOT JUMP AHEAD OF ANY STEP.

### PARTS LIST:



Screw  
(8 pcs)

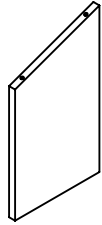

Upright Panel  
(2 pcs)

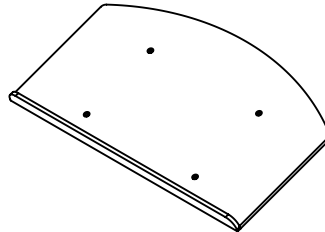

Top Panel  
(1 pcs)

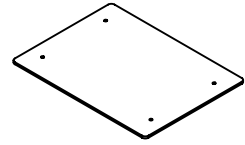

Base Panel  
(1 pcs)

\*TOOLS REQUIRED : SCREWDRIVER  
\*TWO PERSON ASSEMBLY RECOMMENDED

**STEP 1:** Screw the Base Panel to the Upright Panels as shown below. It is best to lay the unit on its back with the uprights supported in to avoid stress on the screws.

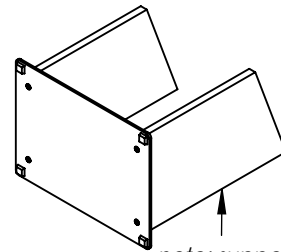
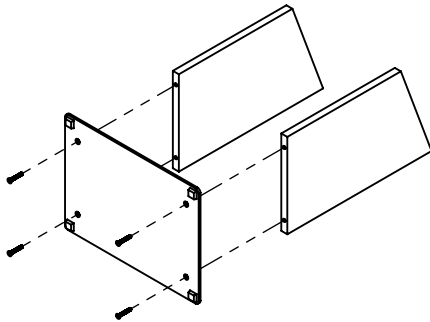

*note: support each Upright on back face to avoid stress on Screws*

**STEP 2:** Carefully rotate the unit to sit on its Base Panel. Then, screw the Top Panel to the Uprights as shown below.

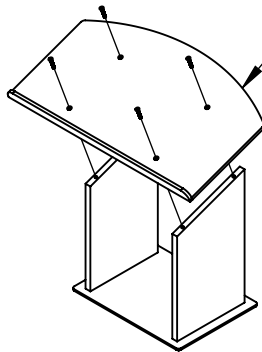
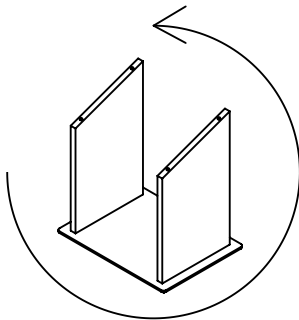

*note: it is best to have one person support and position the Top Panel as other person inserts Screws*

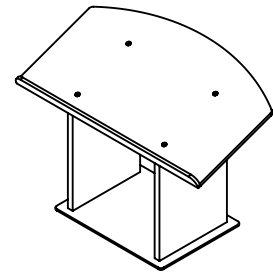
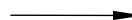

**ASSEMBLY  
COMPLETED**